

**\*所有原料材质，生产制程，电镀必须符合RoHS要求\***

REV.	ECN NO.	LOCAS.	DESCRIPTION	DATE	DESIGN
AO			RELEASE TO CUSTOMER	170116	RYAN

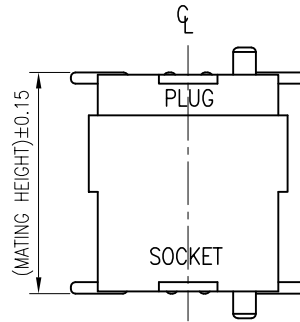

MATING HEIGHT  
SCALE:1.25:1

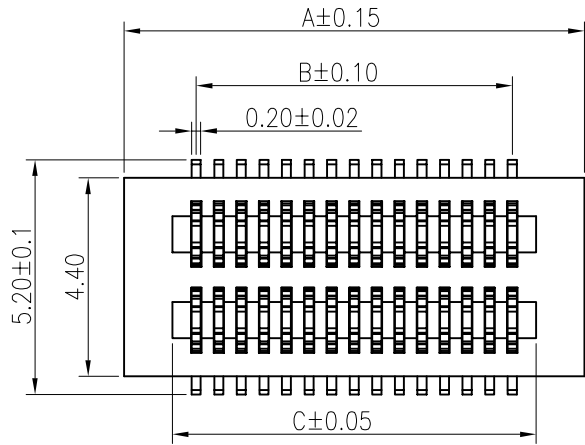
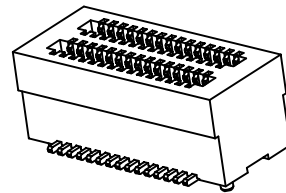
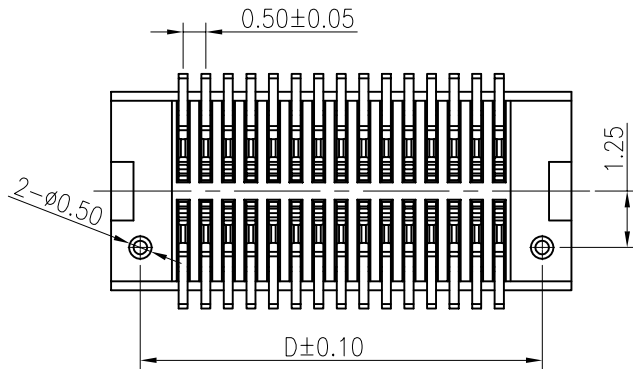
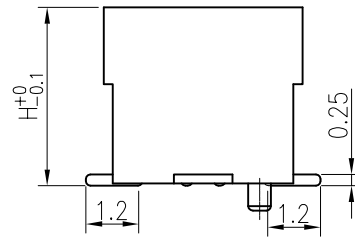
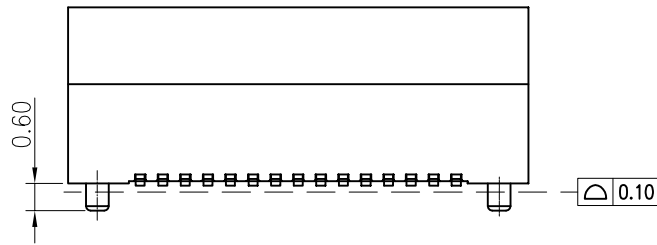

3D VIEW

MATING HEIGHT	PLUG (H.)	SOCKET (H.)	NO.of contacts	Dimensions				NO.of contacts	Dimensions			
				A	B	C	D		A	B	C	D
3.0	0.8	2.2	4	3.70	0.50	1.56	2.40	54	16.20	13.00	14.06	14.90
3.5	1.3	2.2	6	4.20	1.00	2.06	2.90	56	16.70	13.50	14.56	15.40
4.0	1.0	3.0	8	4.70	1.50	2.56	3.40	58	17.20	14.00	15.06	15.90
4.5	1.0	3.5	10	5.20	2.00	3.06	3.90	60	17.70	14.50	15.56	16.40
5.0	1.0	4.0	12	5.70	2.50	3.56	4.40	62	18.20	15.00	16.06	16.90
5.5	1.0	4.5	14	6.20	3.00	4.06	4.90	64	18.70	15.50	16.56	17.40
6.0	2.0	4.0	16	6.70	3.50	4.56	5.40	66	19.20	16.00	17.06	17.90
6.5	2.0	4.5	18	7.20	4.00	5.06	5.90	68	19.70	16.50	17.56	18.40
			20	7.70	4.50	5.56	6.40	70	20.20	17.00	18.06	18.90
			22	8.20	5.00	6.06	6.90	72	20.70	17.50	18.56	19.40
			24	8.70	5.50	6.56	7.40	74	21.20	18.00	19.06	19.90
			26	9.20	6.00	7.06	7.90	76	21.70	18.50	19.56	20.40
			28	9.70	6.50	7.56	8.40	78	22.20	19.00	20.06	20.90
			30	10.20	7.00	8.06	8.90	80	22.70	19.50	20.56	21.40
			32	10.70	7.50	8.56	9.40	82	23.20	20.00	21.06	21.90
			34	11.20	8.00	9.06	9.90	84	23.70	20.50	21.56	22.40
			36	11.70	8.50	9.56	10.40	86	24.20	21.00	22.06	22.90
			38	12.20	9.00	10.06	10.90	88	24.70	21.50	22.56	23.40
			40	12.70	9.50	10.56	11.40	90	25.20	22.00	23.06	23.90
			42	13.20	10.00	11.06	11.90	92	25.70	22.50	23.56	24.40
			44	13.70	10.50	11.56	12.40	94	26.20	23.00	24.06	24.90
			46	14.20	11.00	12.06	12.90	96	26.70	23.50	24.56	25.40
			48	14.70	11.50	12.56	13.40	98	27.20	24.00	25.06	25.90
			50	15.20	12.00	13.06	13.90	100	27.70	24.50	25.56	26.40

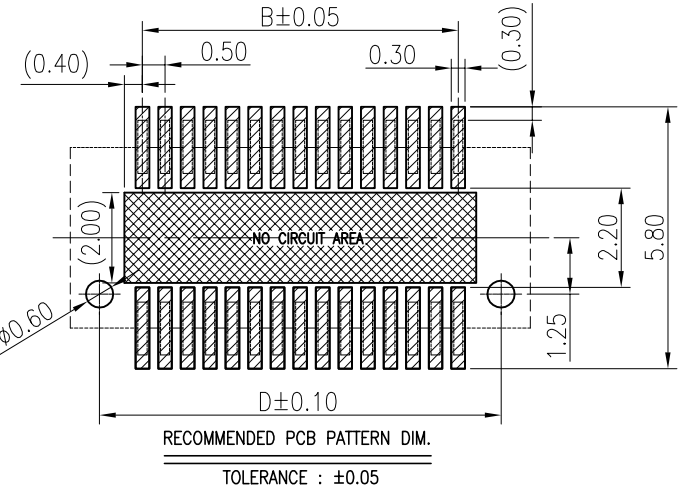

NOTES:

- HUOSING: PA9T HIGH-TEMP THERMOPLASTIC UL94V-0 COLOR:BLACK
- TERMINAL:PHOSPHOR BRONZE  
PLATING:1μ" GOLD FLASH OVERALL 50~100μ" NICKEL UNDER PLATED.
- CODING INFORMATION: BTB-051-XX2-XXB4-11

PIN  
0.5 BTB  
MATING HEIGHT: 30--3.0H;35--3.5H;  
40--4.0H;45--4.5H;  
50--5.0H;55--5.5H;  
60--6.0H;65--6.5H;

DIM	TOL	DIM	TOL
X.	±0.30	X".	±4.0"
X.X	±0.25	X.X"	±3.0"
X.XX	±0.20	X.XX"	±2.0"
X.XXX	±0.10	X.XXX"	±1.0"

THIS DRAWING CONTAINS INFORMATION THAT IS PROVIDED BY LASTAR TECHNOLOGY AND SHOULD NOT BE USED WITHOUT WRITTEN PERMISSION

**LASTAR**

Lastar Technology CO.,LTD

TEL:0755-27157971 FAX:0755-27157976 Http://www.lsdconn.com

DRAW NO.		DATE	DRAW NAME: BTB PITCH0.5MM SOCKET 双槽		
DESIGN	RYAN	170116	P/N NO.	BTB-052-XX2-XXB4-11	SHORT CODE
CHECK	WANGCM	170116	UNIT:	SHEET:	MODEL: B4
APPROVED	HUYX	170116	mm	N/A	REV. AO SCALE N/A