

CATEGORY	DESCRIPTION	P/N #
CONNECTOR	Modular Jack, 8P8C, 1X5PORT	MJ5988-BX15-RF1

REV.	ECN NO	DESCRIPTION	REVISED	DATE
A01		New Release	GMC	2010.03.13

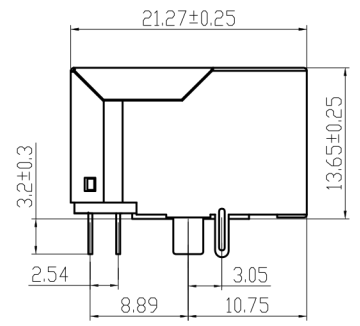
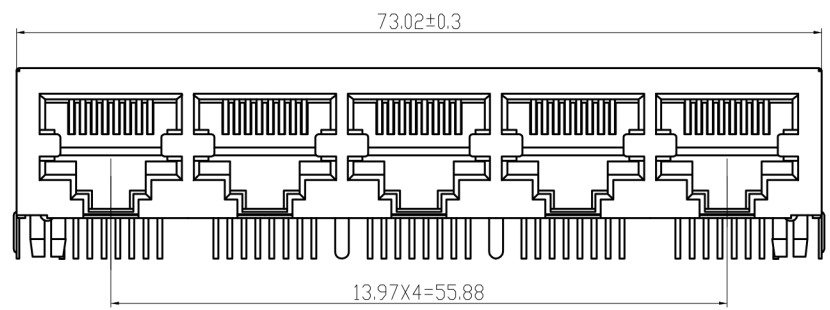

SPECIFICATIONS:

1. Voltage: 150V AC RMS
2. Current Rating: 1.5A
3. Contact Resistance: 30mΩ MAX.
4. Insulation Resistance: 500MΩ MIN.
5. Dielectric Withstang Voltage :1000V AC
6. Operature Temperature: -40°C~80°C
7. Durability: 500 Mating Cycles MIN.

Part No.: MJ5988-BX15-RF1

Material & Plating

Table 1

X	Terminal Plating
0	Au 1u" Plating
1	Au 3u" Plating
2	Au 6u" Plating
3	Au 15u" Plating
4	Au 30u" Plating
5	Au 50u" Plating

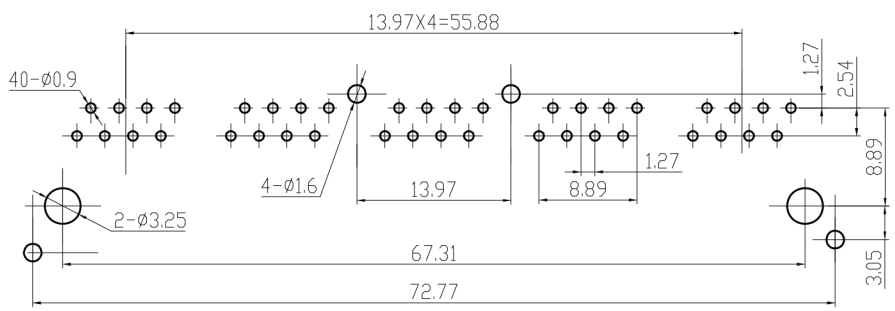
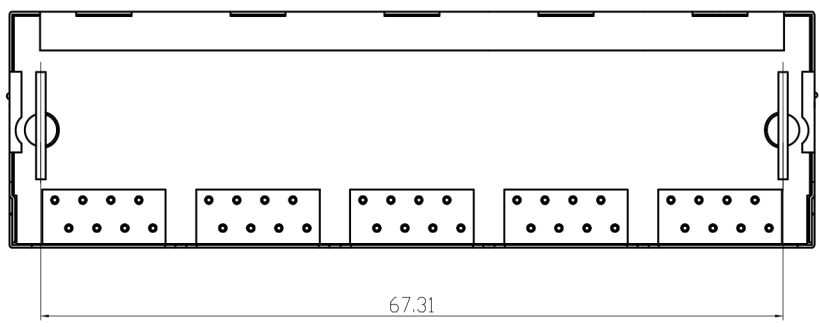

PC Board Layout

贵州省合曜电子科技有限公司
 GuiZhousheng HeYao Electronic Technology Co.,Ltd

NO.	PART NAME	Q'TY	MATERIAL	PLATING & COLOR	Remark
c	Shielding	1	Brass	Ni Plating	
b	Terminal	8	Phosphor Bronze	Terminal Plating	
a	Housing	1	PBT UL94V-0	See Color Scheme	

UNLESS OTHERWISE SPECIFIED TOLERANCES
 DECIMALS: X :±0.5, X.X :±0.3, X.XX :±0.2
 ANGLES: X :±2°, X.X :±1°

SCALE:1/1	UNIT: mm	DWG.NO: WI-061-751
SIZE: A3	PAGE:1 OF 1	REV:A01
APPROVED BY: TONY	CHECKED BY: WZ	PREPARED BY: WZ
CUSTOMER COPY		