

**APPEARANCE**



DFN1610-2L

**PIN CONFIGURATION**



Pin configuration (Top view)

**Descriptions**

The APES20H40-16 is a Uni-directional transient voltage suppressor (TVS) to protect sensitive electronic components from electrostatic discharge (ESD). It is particularly well-suited for cellular phones, PMP, MID, PDA, digital cameras and other electronic equipment. The APES20H40-16 is safely dissipating ESD strikes to meet the ESD immunity testing of IEC61000-4-2 ( $\pm 30KV$ ).

The APES20H40-16 is available in DFN1610 package. Standard products are Pb-free and Halogen-free.

**Order information**

Device	Package	Shipping
APES20H40-16	DFN1610	3000/Tape&Reel

**Electrical Parameters (T=25°C )**

Symbol	Parameter
$V_{RWM}$	Reverse Stand-off Voltage
$I_R$	Reverse Leakage Current @ $V_{RWM}$
$V_{BR}$	Reverse Breakdown Voltage @ $I_T$
$I_T$	Test Current
$I_{PP}$	Reverse Peak Pulse Current
$V_C$	Clamping Voltage @ $I_{PP}$
$I_F$	Forward Current
$V_F$	Forward Voltage @ $I_F$

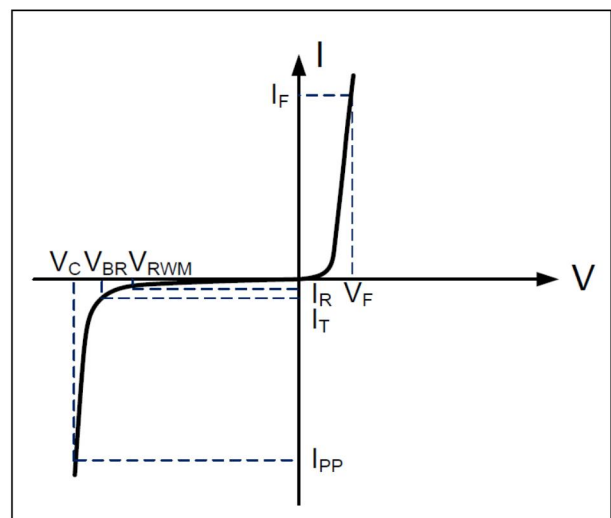

**Absolute maximum ratings**

Parameter	Symbol	Rating	Unit
Peak pulse power (tp = 8/20μs)	Ppk	1500	W
Peak pulse current (tp = 8/20μs)	I <sub>PP</sub>	40	A
ESD according to IEC61000-4-2 air discharge	V <sub>ESD</sub>	±30	kV
ESD according to IEC61000-4-2 contact discharge		±30	kV
Junction temperature	T <sub>J</sub>	150	°C
Operating temperature	T <sub>OP</sub>	-55~125	°C
Storage temperature	T <sub>STG</sub>	-55~150	°C

**Electronics characteristics (Ta=25°C)**

Parameter	Symbol	Condition	Min	Typ	Max	Units
Reverse Stand-off Voltage	VRWM				20	V
Reverse Breakdown Voltage	VBR	I <sub>t</sub> =1mA	20	22	26	V
Reverse Leakage Current	I <sub>R</sub>	VRWM=20V			0.2	uA
Clamping Voltage	V <sub>C</sub>	I <sub>pp</sub> =40A, tp=8/20us			40	V
Junction Capacitance	C <sub>j</sub>	VR=0V, f=1MHz		220		pF

**Typical characteristics (Ta=25°C)**

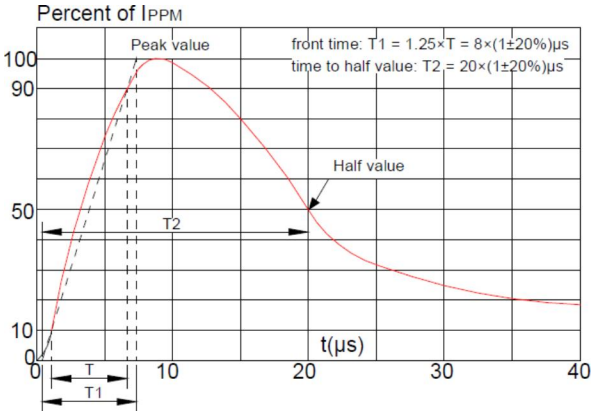

**Pulse Waveform (8/20us)**

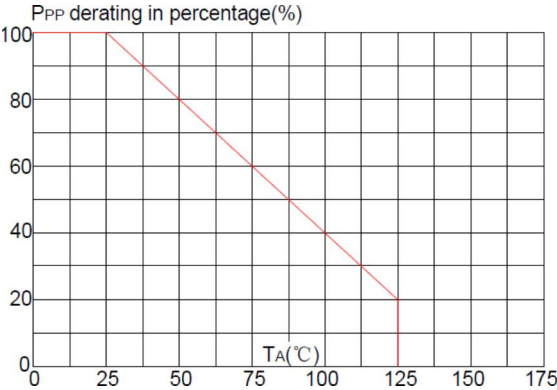

**Pulse Derating Curve**

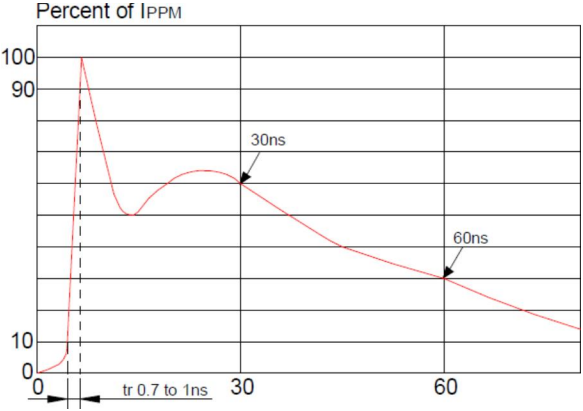

**ESD Clamping(8kV Contact Discharge )**

**PACKAGE OUTLINE DIMENSIONS(DFN1610-2L)**

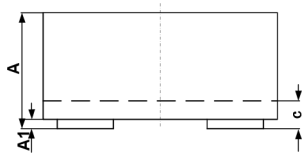
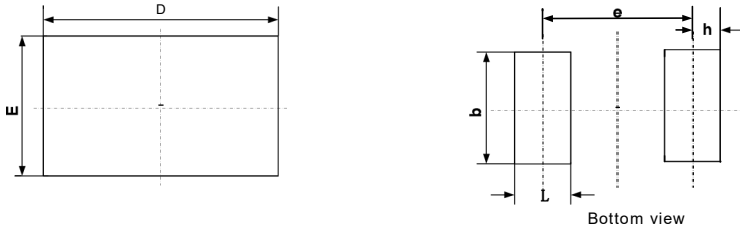

SYM	DIMENSIONS					
	MILLIMETERS			INCHES		
	MIN	NOM	MAX	MIN	NOM	MAX
A	0.45	0.50	0.55	0.018	0.020	0.022
A1	0.00	0.02	0.05	0.000	0.001	0.002
b	0.75	0.80	0.95	0.030	0.032	0.038
c	0.10	0.15	0.20	0.004	0.006	0.008
D	1.55	1.60	1.65	0.062	0.064	0.066
e	1.10 BSC			0.044 BSC		
E	0.95	1.00	1.05	0.038	0.040	0.042
L	0.35	0.40	0.45	0.014	0.016	0.018

suggested Land pattern

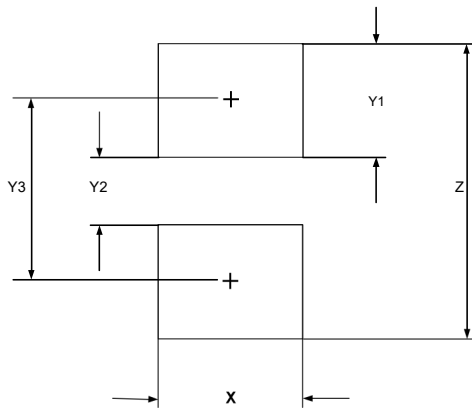

SYM	DIMENSIONS	
	MILLIMETERS	INCHES
X	1.00	0.040
Y1	0.62	0.025
Y2	0.60	0.024
Y3	1.22	0.049
Z	1.85	0.074

**Note:**

This recommended land pattern is for reference purpose only.