

APPEARANCE



DFN1610-2L

PIN CONFIGURATION



Pin configuration (Top view)

Descriptions

The APES4.5H130-16 is a Uni-directional transient voltage suppressor (TVS) to protect sensitive electronic components from electrostatic discharge (ESD). It is particularly well-suited for cellular phones, PMP , MID, PDA, digital cameras and other electronic equipment. The APES4.5H130-16 is safely dissipating ESD strikes to meet the ESD immunity testing of IEC61000-4-2 ($\pm 30KV$).

The APES4.5H130-16 is available in DFN1610 package. Standard products are Pb-free and Halogen-free.

Order information

Device	Package	Shipping
APES4.5H130-16	DFN1610	3000/Tape&Reel

Electrical Parameters (T=25°C)

Symbol	Parameter
V_{RWM}	Reverse Stand-off Voltage
I_R	Reverse Leakage Current @ V_{RWM}
V_{BR}	Reverse Breakdown Voltage @ I_T
I_T	Test Current
I_{PP}	Reverse Peak Pulse Current
V_C	Clamping Voltage @ I_{PP}
I_F	Forward Current
V_F	Forward Voltage @ I_F

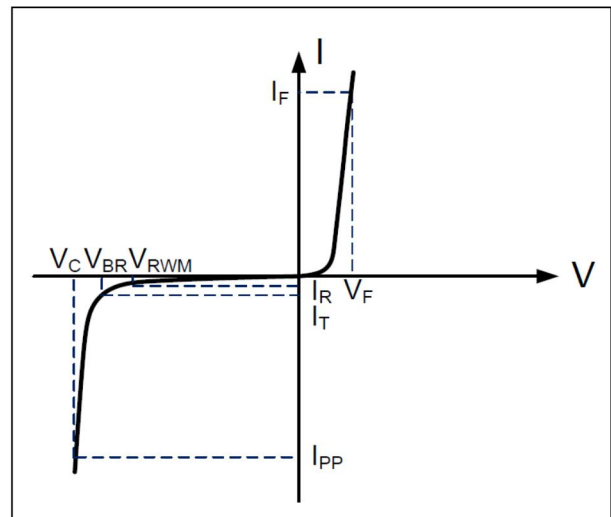

Absolute maximum ratings

Parameter	Symbol	Rating	Unit
Peak pulse power (tp = 8/20μs)	Ppk	2000	W
Peak pulse current (tp = 8/20μs)	I _{PP}	130	A
ESD according to IEC61000-4-2 air discharge	V _{ESD}	±30	kV
ESD according to IEC61000-4-2 contact discharge		±30	kV
Junction temperature	T _J	150	°C
Operating temperature	T _{OP}	-55~125	°C
Storage temperature	T _{STG}	-55~150	°C

Electronics characteristics (Ta=25°C)

Parameter	Symbol	Condition	Min	Typ	Max	Units
Reverse Stand-off Voltage	VRWM				4.5	V
Reverse Breakdown Voltage	VBR	I _t =1mA	5.0		7.0	V
Reverse Leakage Current	I _R	VRWM=4.5V			0.8	uA
Clamping Voltage	V _C	I _{pp} =130A, tp=8/20us			16	V
Junction Capacitance	C _j	VR=0V, f=1MHz		1000		pF

Typical characteristics (Ta=25°C)

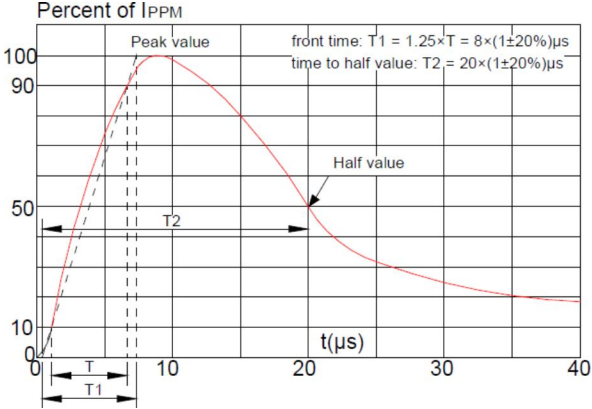

Pulse Waveform (8/20us)

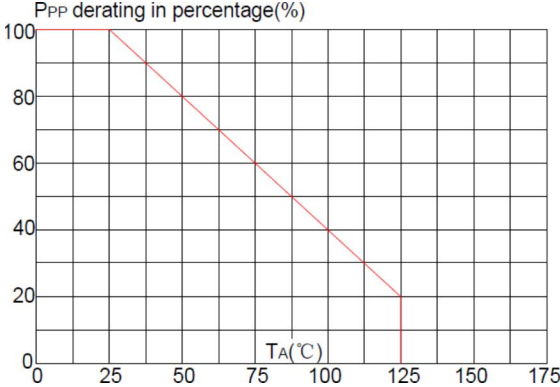

Pulse Derating Curve

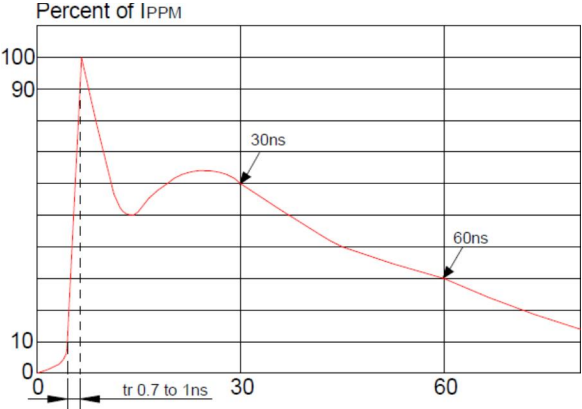

ESD Clamping(8kV Contact Discharge)

PACKAGE OUTLINE DIMENSIONS(DFN1610-2L)

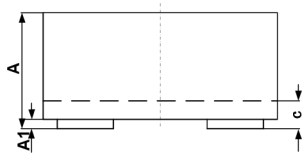
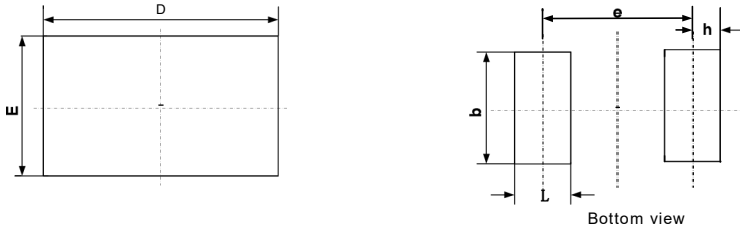

SYM	DIMENSIONS					
	MILLIMETERS			INCHES		
	MIN	NOM	MAX	MIN	NOM	MAX
A	0.45	0.50	0.55	0.018	0.020	0.022
A1	0.00	0.02	0.05	0.000	0.001	0.002
b	0.75	0.80	0.95	0.030	0.032	0.038
c	0.10	0.15	0.20	0.004	0.006	0.008
D	1.55	1.60	1.65	0.062	0.064	0.066
e	1.10 BSC			0.044 BSC		
E	0.95	1.00	1.05	0.038	0.040	0.042
L	0.35	0.40	0.45	0.014	0.016	0.018

suggested Land pattern

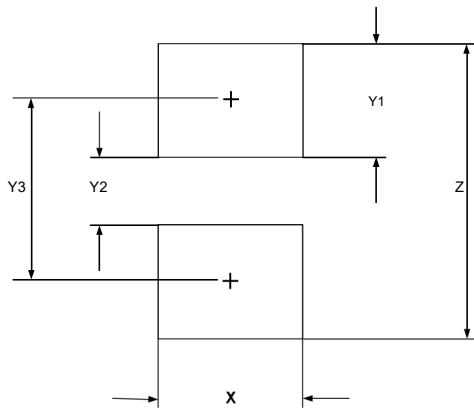

SYM	DIMENSIONS	
	MILLIMETERS	INCHES
X	1.00	0.040
Y1	0.62	0.025
Y2	0.60	0.024
Y3	1.22	0.049
Z	1.85	0.074

Note:

This recommended land pattern is for reference purpose only.