

■ SPECIFICATIONS

- Current Rating : 3A AC/DC
- Voltage Rating : 250V AC/DC
- Withstanding Voltage : 1,000V AC/minute
- Insulation Resistance : 1,000MΩ min.
- Temperature Range : - 25°C to + 85°C
- Contact Resistance : 20mΩ max.

■ HOUSING

- Part No. : GJS-11051-XXx2

①

① Poles : 2x2~25x2

- Material : PPO UL94V-0,Black
- Mating Wafer : GJS-1106X-XXx2 & GJS-1107X-XXx2
- Mating Terminal : GJS-11051-XXTPXX

Poles	Dimensions (mm)		Poles	Dimensions (mm)	
	A	B		A	B
2x2	2.54	5.08	14x2	33.02	35.56
3x2	5.08	7.62	15x2	35.56	38.10
4x2	7.62	10.16	16x2	38.10	40.64
5x2	10.16	12.70	17x2	40.64	43.18
6x2	12.70	15.24	18x2	43.18	45.72
7x2	15.24	17.78	19x2	45.72	48.26
8x2	17.78	20.32	20x2	48.26	50.80
9x2	20.32	22.86	21x2	50.80	53.34
10x2	22.86	25.40	22x2	53.34	55.88
11x2	25.40	27.94	23x2	55.88	58.42
12x2	27.94	30.48	24x2	58.42	60.96
13x2	30.48	33.02	25x2	60.96	63.50



东莞乔唯电子有限公司
DONGGUAN CHYAO WEI
ELECTRONIC CO., LTD

APPROVED BY	SCALE	UNIT	TOLERANCE	LTR	REVISION RECORD	NAME	DATE	LTR	REVISION RECORD	NAME	DATE
張育瑞		mm	.0 ±0.30	△				△			
CHECKED BY	PROJ	VER NO.	.00 ±0.20	△				△			
劉娜	⊕ □	a0	.000 ±0.10	△				△			
DRAWN BY	DATE	SIZE	ANGLE	△							
曾慶根	2020/11/16	A4	0° ±1°	△							
			.0° ±	△							
			SHEET 1/1	△							

CUSTOMER
Conforms to The RoHS Instruction

PART NO | GJS-11051-XXx2
2.54mm Center Mini Latch Housing

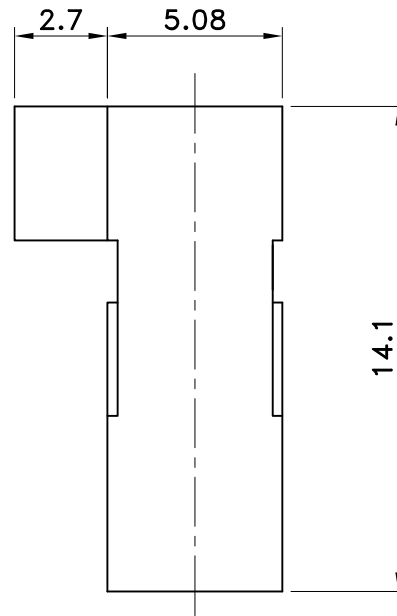
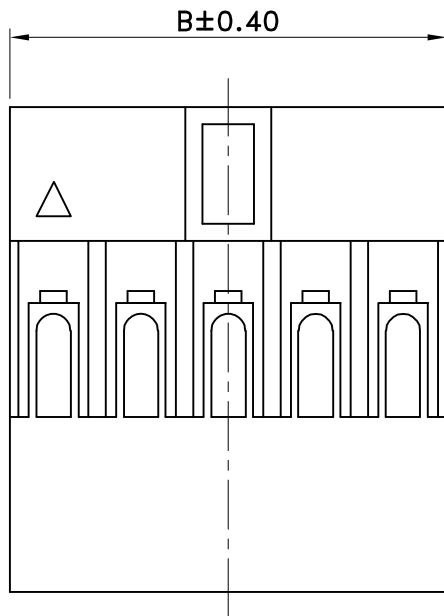
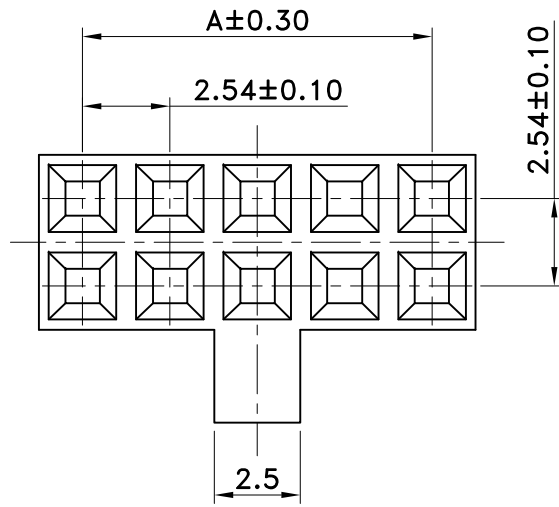

■ SPECIFICATIONS

- Current Rating : 2.5A AC/DC
- Voltage Rating : 250V AC/DC
- Withstanding Voltage : 800V AC/minute
- Insulation Resistance : 1,000MΩ min.
- Temperature Range : - 25°C to + 85°C
- Contact Resistance : 20mΩ max.

■ HOUSING

- Part No. : GJS-1105B1-XXx2

①

① Poles : 2x2~25x2

- Material : PPO UL94V-0,Black
- Mating Wafer : GJS-1106X-XXx2 & GJS-1107X-XXx2
- Mating Terminal : GJS-11051-XXTPXX

Poles	Dimensions (mm)		Poles	Dimensions (mm)	
	A	B		A	B
2x2	2.54	5.08	14x2	33.02	35.56
3x2	5.08	7.62	15x2	35.56	38.10
4x2	7.62	10.16	16x2	38.10	40.64
5x2	10.16	12.70	17x2	40.64	43.18
6x2	12.70	15.24	18x2	43.18	45.72
7x2	15.24	17.78	19x2	45.72	48.26
8x2	17.78	20.32	20x2	48.26	50.80
9x2	20.32	22.86	21x2	50.80	53.34
10x2	22.86	25.40	22x2	53.34	55.88
11x2	25.40	27.94	23x2	55.88	58.42
12x2	27.94	30.48	24x2	58.42	60.96
13x2	30.48	33.02	25x2	60.96	63.50



东莞乔唯电子有限公司
DONGGUAN CHYAO WEI
ELECTRONIC CO., LTD

APPROVED BY	SCALE	UNIT	TOLERANCE	LTR	REVISION RECORD	NAME	DATE	LTR	REVISION RECORD	NAME	DATE
张育瑞		mm	.0 ±0.30	△				△			
CHECKED BY	PROJ	VER NO.	.00 ±0.20	△				△			
曾庆根		a0	.000 ±0.10	△				△			
DRAWN BY	DATE	SIZE	ANGLE	△				△			
曾庆根	2020/11/16	A4	0° ±1°	△				△			
			.0° ±	△				△			
			SHEET 1/1	△				△			

CUSTOMER
Conforms to The RoHS Instruction

PART NO GJS-1105B1-XXx2

2.54mm Center Mini Latch Housing

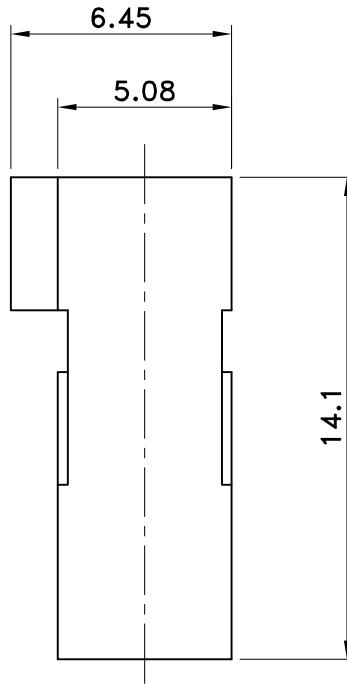
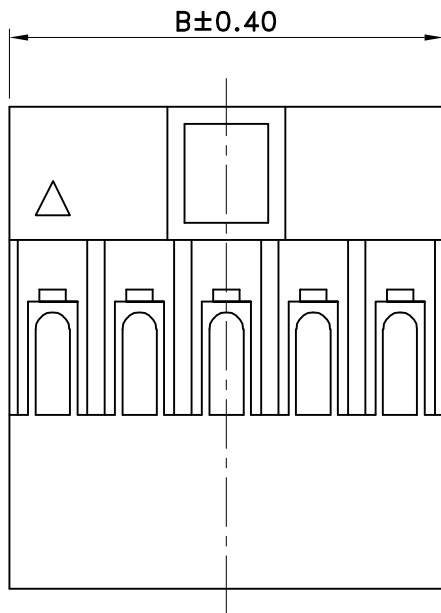
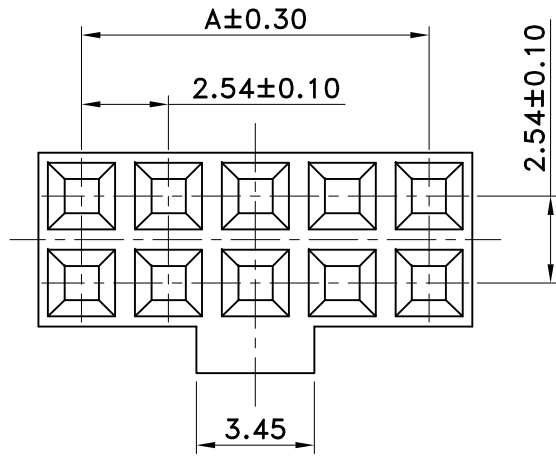

■ SPECIFICATIONS

- Current Rating : 2.5A AC/DC
- Voltage Rating : 250V AC/DC
- Withstanding Voltage : 800V AC/minute
- Insulation Resistance : 1,000MΩ min.
- Temperature Range : - 25°C to + 85°C
- Contact Resistance : 20mΩ max.

■ HOUSING

- Part No. : GJS-1105B2-XXx2

①

① Poles : 2x2~25x2

- Material : PPO UL94V-0,Black
- Mating Wafer : GJS-1106X-XXx2 & GJS-1107X-XXx2
- Mating Terminal : GJS-11051-XXTPXX

Poles	Dimensions (mm)		Poles	Dimensions (mm)	
	A	B		A	B
2x2	2.54	5.08	14x2	33.02	35.56
3x2	5.08	7.62	15x2	35.56	38.10
4x2	7.62	10.16	16x2	38.10	40.64
5x2	10.16	12.70	17x2	40.64	43.18
6x2	12.70	15.24	18x2	43.18	45.72
7x2	15.24	17.78	19x2	45.72	48.26
8x2	17.78	20.32	20x2	48.26	50.80
9x2	20.32	22.86	21x2	50.80	53.34
10x2	22.86	25.40	22x2	53.34	55.88
11x2	25.40	27.94	23x2	55.88	58.42
12x2	27.94	30.48	24x2	58.42	60.96
13x2	30.48	33.02	25x2	60.96	63.50



东莞乔唯电子有限公司
DONGGUAN CHYAO WEI
ELECTRONIC CO., LTD

APPROVED BY	SCALE	UNIT	TOLERANCE	LTR	REVISION RECORD	NAME	DATE	LTR	REVISION RECORD	NAME	DATE
张育瑞		mm	.0 ±0.30	△				△			
CHECKED BY	PROJ	VER NO.	.00 ±0.20	△				△			
曾庆根	⊕ □	α0	.000 ±0.10	△				△			
DRAWN BY	DATE	SIZE	ANGLE	△					CUSTOMER		
曾庆根	2020/11/16	A4	0° ±1°	△					Conforms to The RoHS Instruction		
			.0° ±	△							
			SHEET 1/1	△							

PART NO GJS-1105B2-XXx2
2.54mm Center Mini Latch Housing

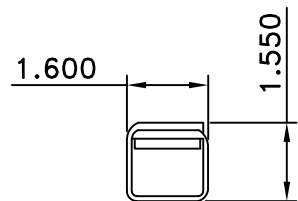
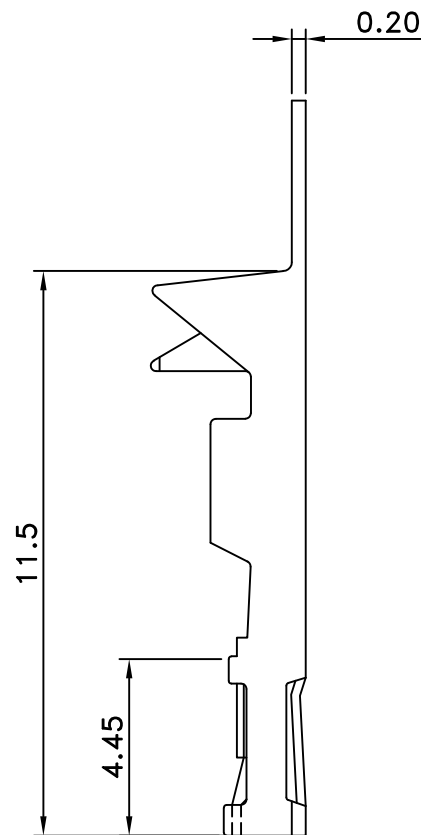
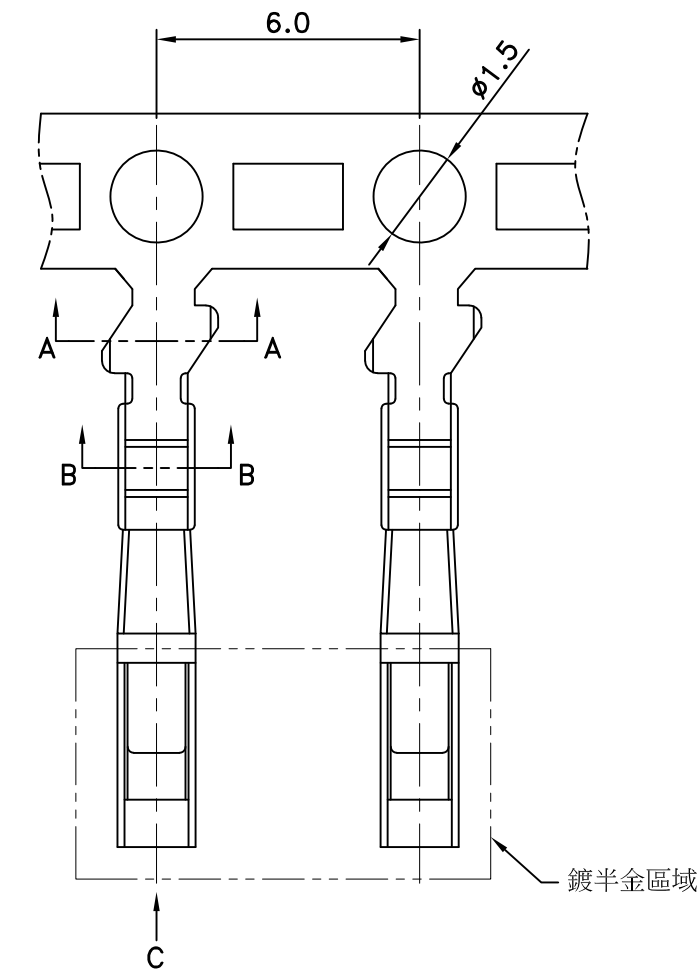

View C

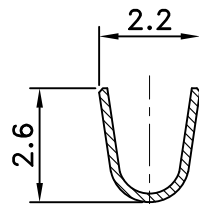

SECTION A-A

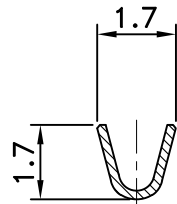

SECTION B-B

■ SPECIFICATIONS

- Voltage Rating :250 V AC/DC
- Current Rating : 3A AC/DC
- Withstanding Voltage : 1000V AC/minute
- Insulation Resistance : 1000M Ω min
- Temperature Range : - 25 $^{\circ}$ C to + 85 $^{\circ}$ C
- Contact Resistance : 20m Ω max

■ TERMINAL

- Part No. : GJS-11051-XXTP XX
① ②

① Material :

- TP : Brass(常规品)
- PBTP : Phosphor Bronze

② Plated :

- Blank : Tin-Plated (先冲后镀)
- SG : Gold Flash (镀半金, 先冲后镀)

- Applicable Wires : AWG# 22-28
- Thickness : 0.2mm
- Q' ty : 10,000 pcs./Reel
- Mates With: GJS-11051-XX Housing



东莞乔唯电子有限公司
DONGGUAN CHYAO WEI
ELECTRONIC CO., LTD

APPROVED BY	SCALE	UNIT	TOLERANCE	LTR	REVISION RECORD	NAME	DATE	LTR	REVISION RECORD	NAME	DATE
張育瑞	N/A	mm	.0 ±0.30	△				△			
CHECKED BY	PROJ	VER NO.	.00 ±0.20	△				△			
劉娜	⊕	α0	.000 ±0.10	△				△			
DRAWN BY	DATE	SIZE	ANGLE	△							
曾慶根	2022/02/17	A4	0° ±1°	△							
			.0° ±	△							
			SHEET 1/1	△							

PART NO GJS-11051-XXTPXX

CUSTOMER

Conforms to The RoHS Instruction

2.54mm Center Mini Latch Terminal

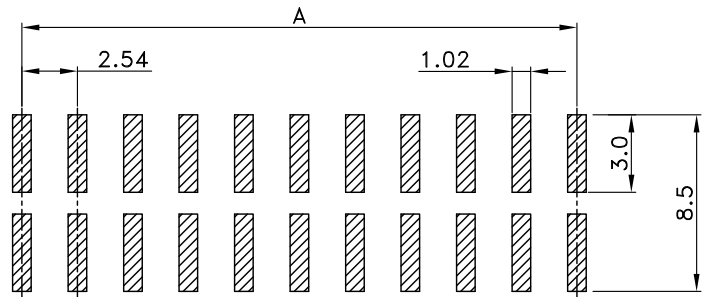

Recommend PCB Layout
General Tolerance ± 0.05

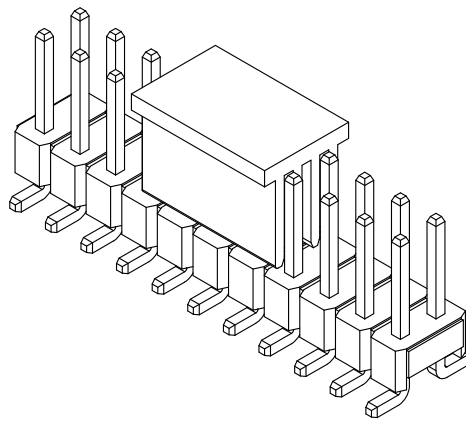
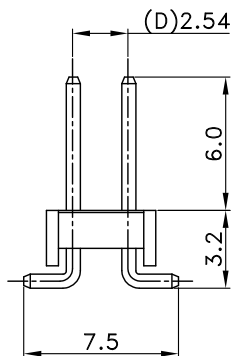
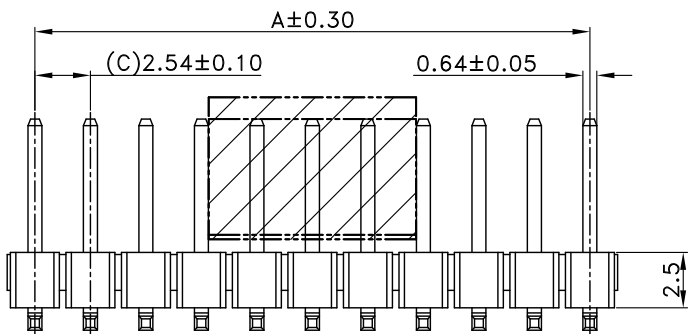
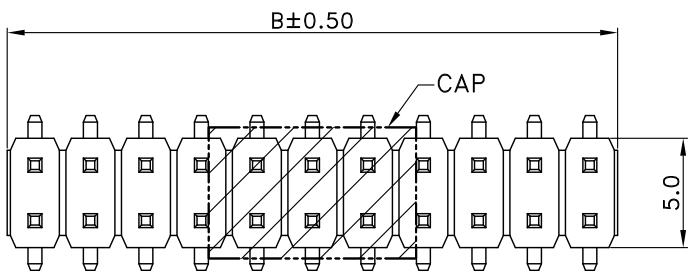

- SPECIFICATIONS
- Current Rating : 3A AC/DC
- Withstanding Voltage : 1000V AC/minute
- Insulation Resistance : 1000MΩ min
- Temperature Range : -40°C ~ +105°C
- Contact Resistance : 20mΩ max

- Feature
- Part No. : GJS-1106SM1-XXx2 X(XX XX D1)XX
① ② ③ ④ ⑤ ⑥

- ① Poles : 02x2 ~ 40x2(Double - Row)
- ② Blank : without cap(Standard)
C : with cap
- ③ Base:
Blank : Nylon 6T UL94V-0
6TNH : Nylon6T-66 UL94V-0;Non-Halogen
- ④ Blank : 0.3~1.5u" Au over 30~80u" NICKEL
G3 : 8~12u" Au over 50~80u" NICKEL
- ⑤ D1 : SMT:7.5、LD:3.2、OD:6.0
- ⑥ Blank : Bag(Standard)
/A : Tube
/R : Reel+cap
- Material :
1.Contact : Brass
2.Bass : Refer The Above Option
- Packing : Refer the above of options

Poles	Dimension		Poles	Dimension	
	A	B		A	B
02x2	2.54	5.08	22x2	53.34	55.88
03x2	5.08	7.62	23x2	55.88	58.42
04x2	7.62	10.16	24x2	58.42	60.96
05x2	10.16	12.70	25x2	60.96	63.50
06x2	12.70	15.24	26x2	63.50	66.04
07x2	15.24	17.78	27x2	66.04	68.58
08x2	17.78	20.32	28x2	68.58	71.12
09x2	20.32	22.86	29x2	71.12	73.66
10x2	22.86	25.40	30x2	73.66	76.20
11x2	25.40	27.94	31x2	76.20	78.74
12x2	27.94	30.48	32x2	78.74	81.28
13x2	30.48	33.02	33x2	81.28	83.82
14x2	33.02	35.56	34x2	83.82	86.36
15x2	35.56	38.10	35x2	86.36	88.90
16x2	38.10	40.64	36x2	88.90	91.44
17x2	40.64	43.18	37x2	91.44	93.98
18x2	43.18	45.72	38x2	93.98	96.52
19x2	45.72	48.26	39x2	96.52	99.06
20x2	48.26	50.80	40x2	99.06	101.60
21x2	50.80	53.34			



东莞乔唯电子有限公司
DONGGUAN CHYAO WEI
ELECTRONIC CO., LTD

APPROVED BY	SCALE	UNIT	TOLERANCE	LTR	REVISION RECORD	NAME	DATE	LTR	REVISION RECORD	NAME	DATE
張育瑞		mm	.0 ±0.30	△				△			
CHECKED BY	PROJ	VER NO.	.00 ±0.20	△				△			
曾慶根		a0	.000 ±0.10	△				△			
DRAWN BY	DATE	SIZE	ANGLE	△							
曾慶根	2020/03/05	A4	0° ±1°	△							
			.0° ±	△							
			SHEET 1/2	△							

PART NO GJS-1106SM1-XXx2X(XXXXD1)XX
2.54mm Board to Board Connector, SMT Pin Header Series

CUSTOMER
Conforms to The RoHS Instruction